

VALVOLINE PROFESSIONAL SERIES™

POWERLINE SERVICE GUIDE

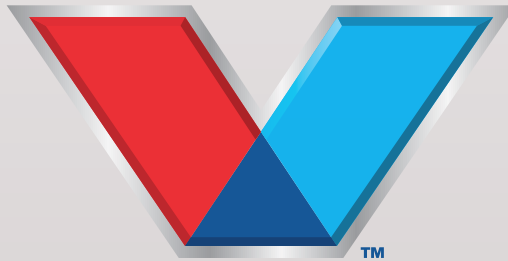

Valvoline™

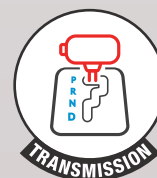



WE'VE GOT YOUR BACK WITH A LIFETIME GUARANTEE.

See complete terms & limitations on this Limited Lifetime Guarantee at valvolineserviceplus.com

TRANSMISSION | BRAKE SYSTEM | COOLING SYSTEM | POWER STEERING
FUEL SYSTEM | DRIVE LINE SYSTEM | ENGINE CLEANING

LEVEL 1	Coverage Up To \$4,000	First Service Before 50,000 MILES
LEVEL 2	Coverage Up To \$2,000	First Service Before 100,000 MILES
LEVEL 3	Coverage Up To \$1,000	First Service Before 125,000 MILES
LEVEL 4	Coverage Up To \$500	First Service Before 150,000 MILES

TO MAINTAIN YOUR COVERAGE:

1.

REPEAT YOUR SERVICE
AT REQUIRED INTERVALS

2.

KEEP YOUR
RECEIPTS

3.

RETURN TO ORIGINAL
SERVICE PROVIDER

Vehicle coverage based on mileage at the time of first service. Coverage takes effect after 500 miles. Taxes, miscellaneous fees, core charges & diagnostics not covered.

VPS GUARANTEE



BRAKE FLUID SERVICE PUT A FULL STOP TO SPONGY BRAKES.



WHAT'S THE PROBLEM?

Brake fluid absorbs moisture over time, reducing your car's stopping power and can cause:

- Brake Failure
- Corrosion
- Sluggish brake response

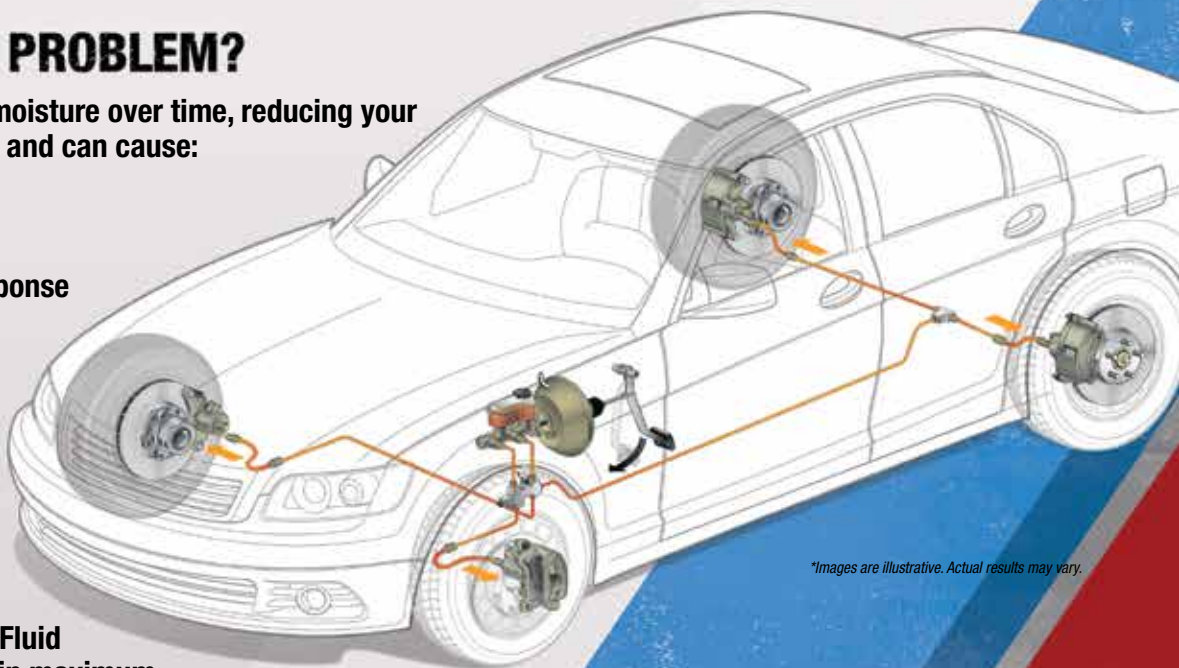

**Images are illustrative. Actual results may vary.*



WHAT'S THE SOLUTION?

Our Valvoline™ Brake Fluid Service helps maintain maximum stopping power by:

- Removing contaminated fluid
- Cleaning the entire system
- Replenishing with new premium dry formula to protect against moisture-related failure

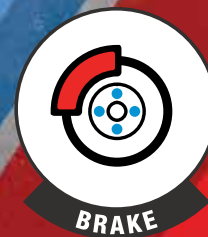

BRAKE FLUID SERVICE



COOLING SYSTEM SERVICE KEEP YOUR COOL. AVOID BREAKDOWN.



WHAT'S THE PROBLEM?

Over time, coolant loses some of its protective properties and its concentration can change, leading to:

- Overheating
- Freezing
- Reduced Flow
- Rust
- Corrosion
- Breakdown

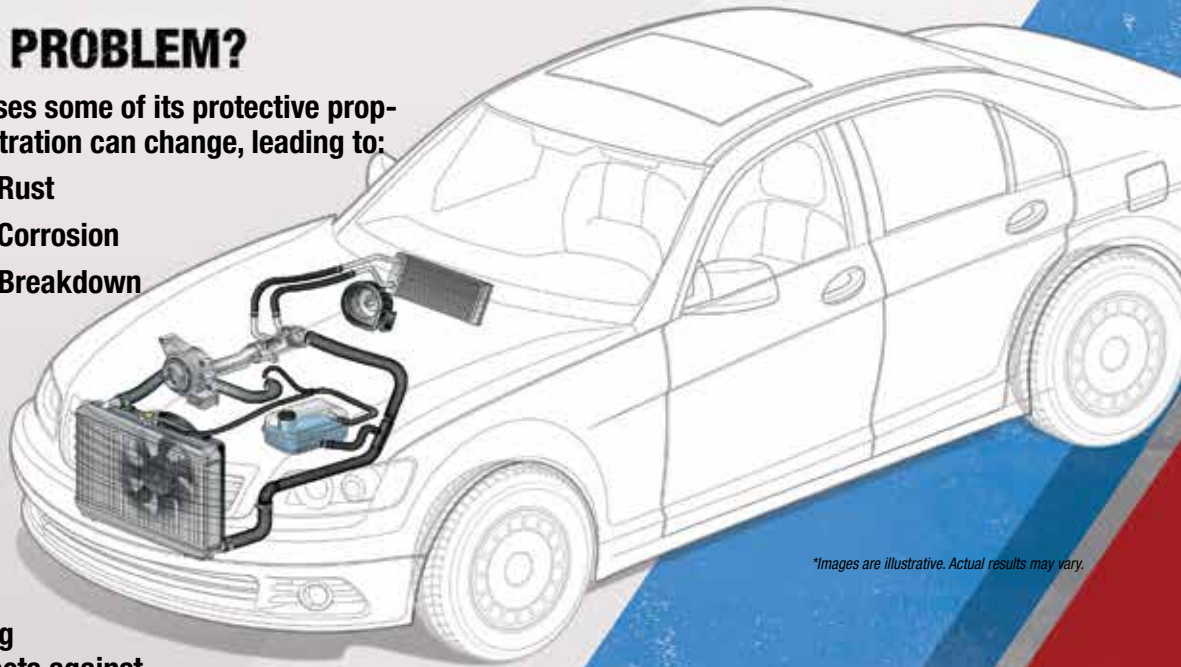

**Images are illustrative. Actual results may vary.*

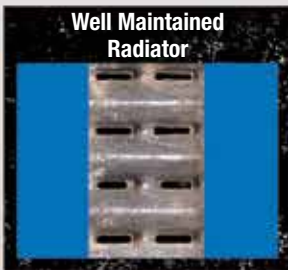

WHAT'S THE SOLUTION?

Our Valvoline™ Cooling System Service protects against engine overheating by:

- Using advanced detergents to fully clean the radiator
- Replenishing the system with new fluid
- Adding sealers designed to prevent against leaks

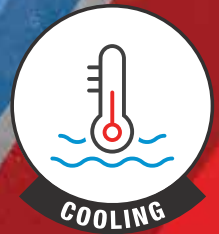

COOLING SYSTEM SERVICE



EASYGDI™ FUEL SYSTEM SERVICE

SPUTTERING, HESITATION, LOST ACCELERATION?

CARBON DEPOSITS IN YOUR ENGINE COULD BE THE CAUSE.

WHAT IS GASOLINE DIRECT INJECTION?

- A fuel delivery technology that allows gasoline engines to burn fuel more efficiently by directly injecting gasoline into the combustion chamber
- Provides more power, cleaner emissions, and increased fuel economy
- Tendency to develop carbon deposits on intake valves, fuel injectors, ports and the entire combustion chamber

WHAT CAN AN EASYGDI™ SERVICE DO FOR YOUR VEHICLE?

- Designed to restore fuel economy, emissions and power
- Works to eliminate rough idle, hesitation and knocking
- Removes carbon deposits from hard to reach Intake Valves, Piston Tops, Cylinder Heads and Fuel Injectors in Gasoline Direct Injection engines

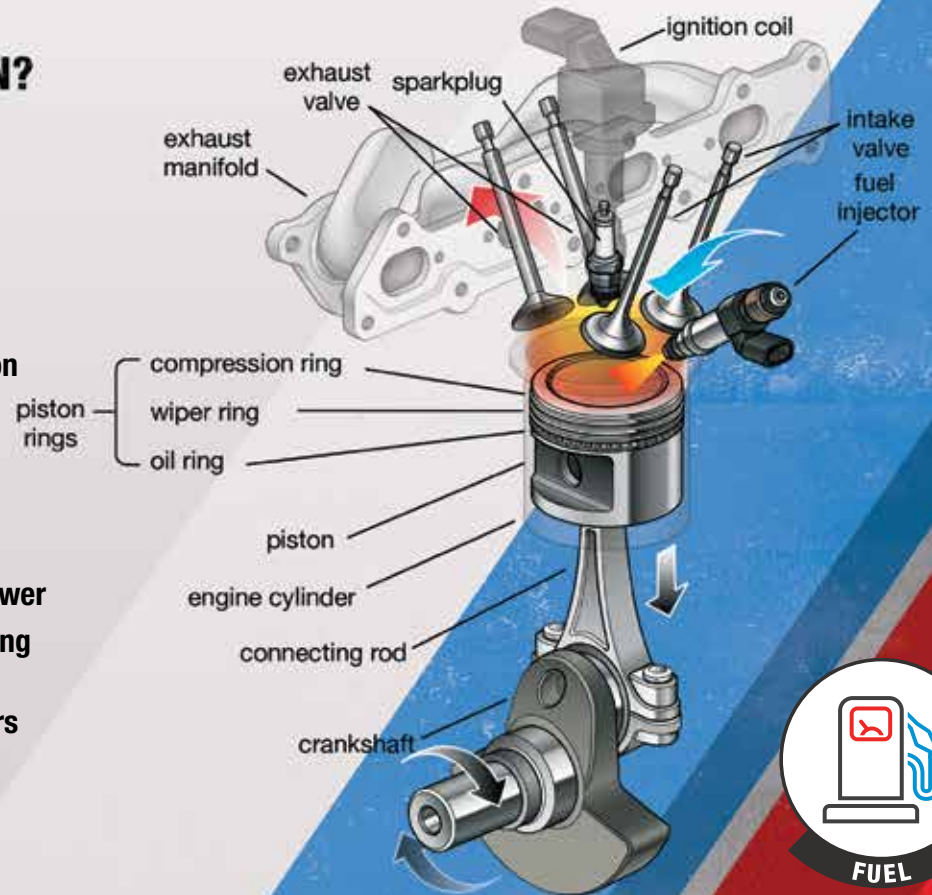

FUEL SYSTEM SERVICE



FUEL SYSTEM SERVICE **DRIVERS, RESTART YOUR ENGINES.**

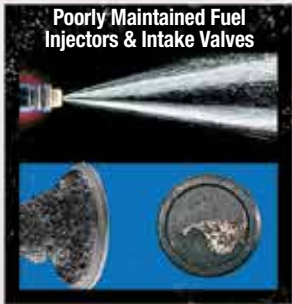

WHAT'S THE PROBLEM?

Deposits in your fuel system cause blockages that can lead to:

- Lost acceleration
- Rough idling
- Hesitation

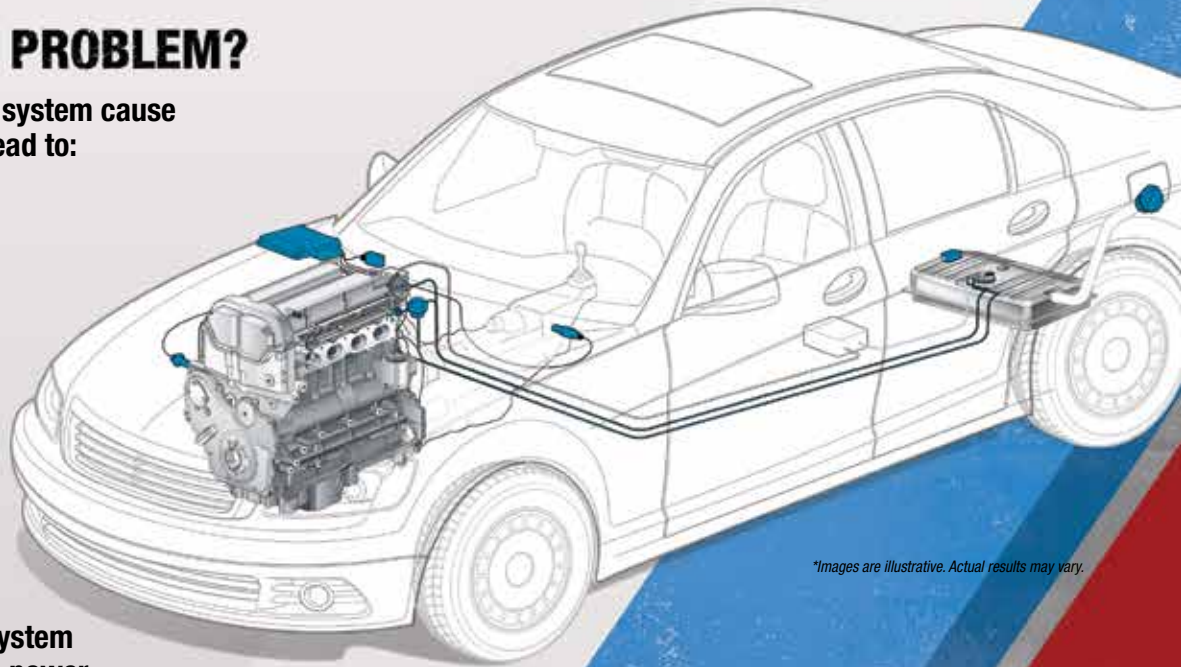

**Images are illustrative. Actual results may vary.*

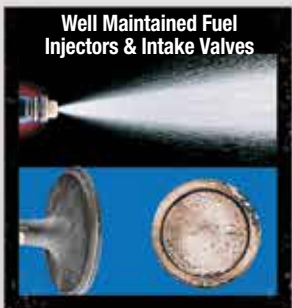

WHAT'S THE SOLUTION?

Our Valvoline™ Fuel System Service helps restore power and performance to your engine by:

- Using advanced detergents to fully clean the system
- Removing carbon deposits, grease, dirt and sludge



FUEL SYSTEM SERVICE



POWER STEERING SERVICE PUT THE POWER BACK IN YOUR STEERING.

Poorly Maintained
Steering Fluid



WHAT'S THE PROBLEM?

Wear metal and particulates build up in old fluid and can cause:

- Stiff steering
- Squealing
- Fluid leaks
- Eventual system failure

Well Maintained
Steering Fluid



WHAT'S THE SOLUTION?

Our Valvoline™ Power Steering Service helps achieve optimal steering performance by:

- Providing powerful solvent action to flush and remove wear metals and particulates that can physically degrade the system
- Replacing old fluid with a premium full synthetic power steering fluid

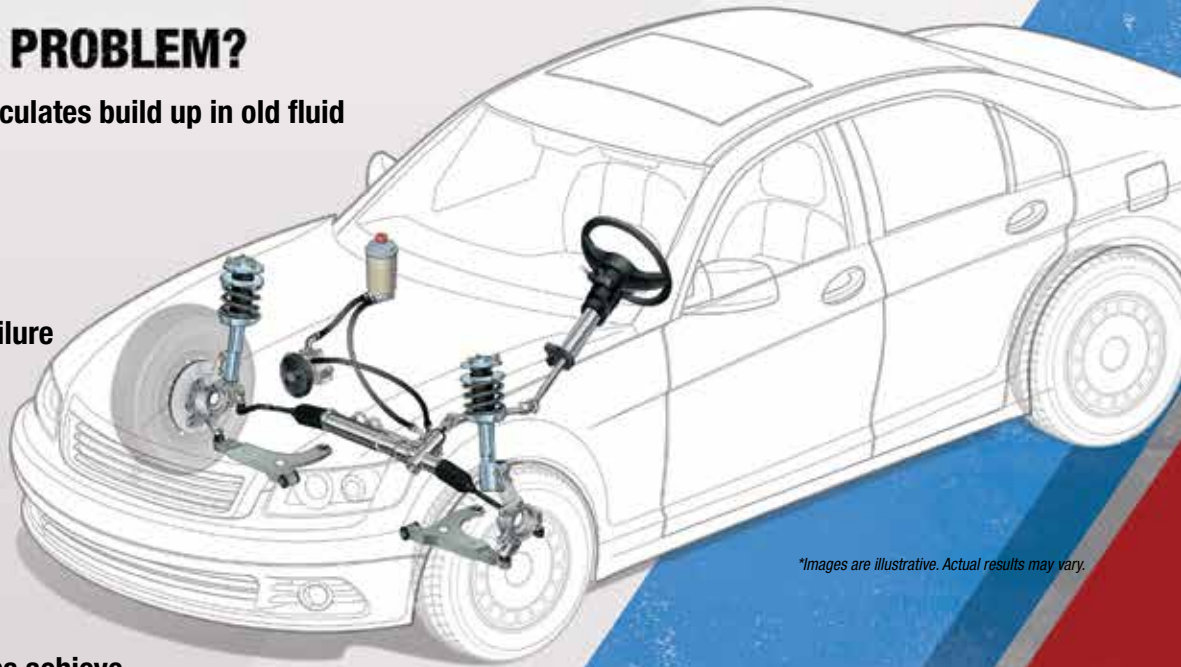

**Images are illustrative. Actual results may vary.*



POWER STEERING SERVICE



TRANSMISSION SERVICE WE KNOW WHAT REALLY GRINDS YOUR GEARS.

Poorly Maintained
Transmission



WHAT'S THE PROBLEM?

Buildup of deposits in fluid can cause debris resulting in:

- Overheating
- Delayed shifting
- Transmission failure
- Poor shift quality

Well Maintained
Transmission



WHAT'S THE SOLUTION?

Our Valvoline™ Transmission Service helps keep your vehicle shifting smoothly by:

- Removing deposits and contaminated fluid
- Replenishing system with new fluid
- Adding advanced conditioners designed to rejuvenate seals
- Removing wear metals and particulates

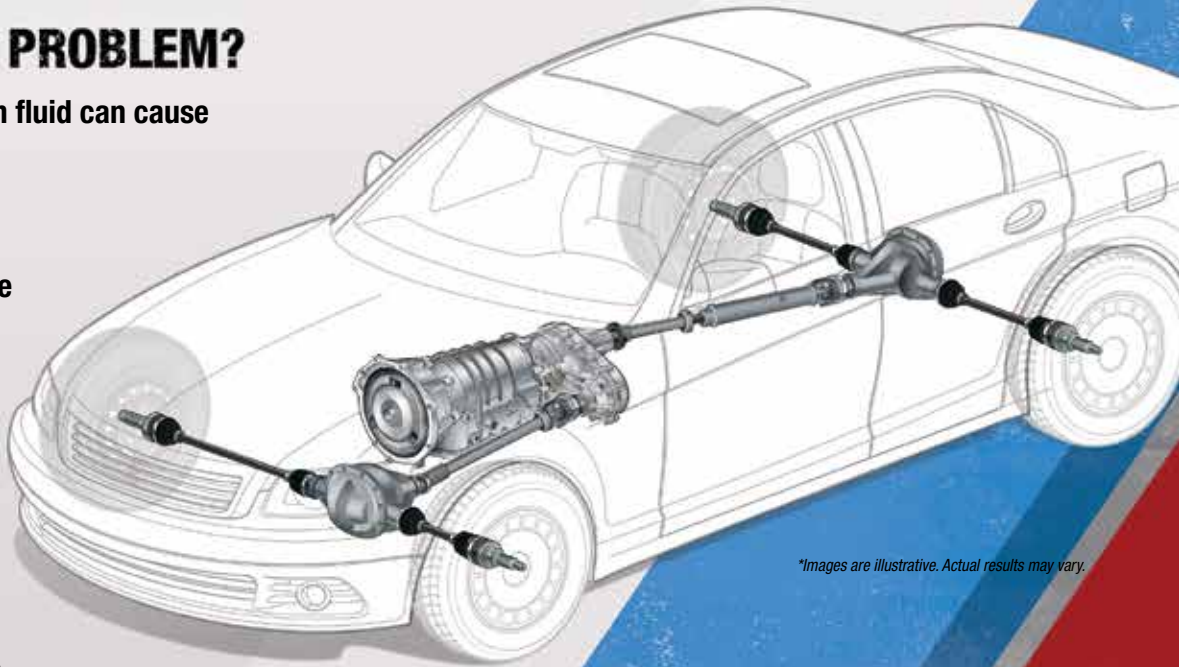

**Images are illustrative. Actual results may vary.*

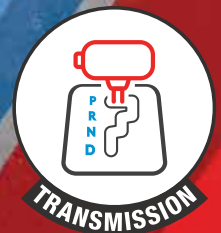

TRANSMISSION SERVICE



Valvoline™